

Article number: 51030400000010

Description: Vibration damper GS-M2  
80x60x2000-5, NR shore 57

## Measures

---

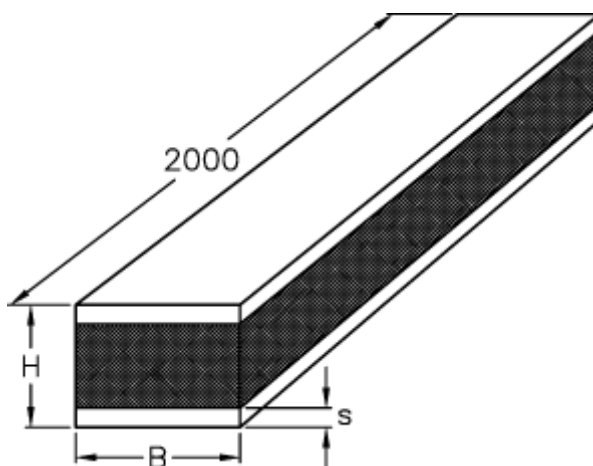

B = 80  
H = 60  
S = 5